



ACCUMAX  
GLOBAL

# Portable Battery Lighting

EDITION 1



# Portable Flash Lights

## AM-T2 Head Light

### PRODUCT FEATURES

- » 6 light modes
- » High brightness lighting
- » Type-C charging
- » 360° rotatable
- » Pattern memory
- » Minimum standby power consumption

Specification	Description
Power	3W (Max spotlight) / 3W (Max floodlight)
Output	Spotlight > 260LM / Flood light > 320LM
Battery	3.7V 2000mAh rechargeable lithium battery
Battery Duration	14-40h
Charging time	2.5h
Dimension	75.5x52.5x47mm
Weight	80g(without headband)

Package	Description
Size of Box	85x50x90mm
Gross Weight	150g
Size of Carton	480x460x130mm
Gross Weight	9.0kg
Box Quantity/ Carton	50Pcs

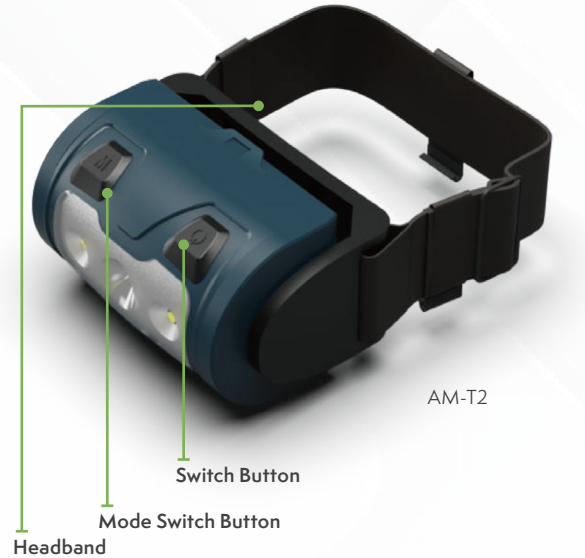

\*If the product is stored for a long time, it needs to be maintained every 3 months: charging--> discharging --> charging

### DIMENSION

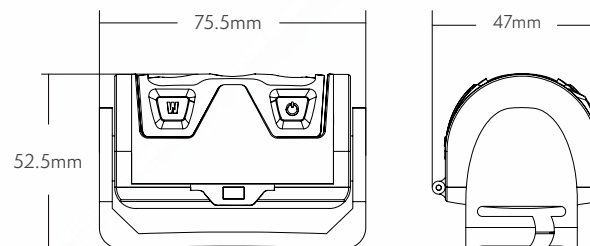

### 6 WORKING MODES

- » Spotlight for long-distance lighting
- » Floodlight for large space lighting

### APPLICATION

- » Camping
- » Construction
- » Emergency
- » Hunting
- » Maintenance
- » Sports

#### Spotlight mode



High Output Mode  
(Duration>11h)



Low Output Mode  
(Duration>21h)

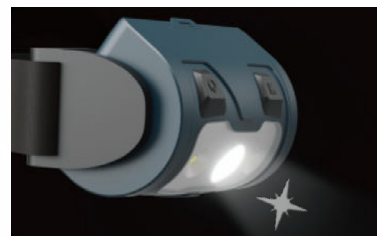

Flash Mode  
(Duration>9h)

#### Floodlight mode



High Output Mode  
(Duration>15h)



Low Output Mode  
(Duration>35h)



Ultra Long Battery Life  
Mode (Duration>90h)

# AM-S3 Flash Light

## APPLICATION

- » Warning
- » Search
- » Emergency/Maintenance
- » Camping

Specification	Description	
Model	Spotlight	Floodlight
Wattage	3W(Max)	6W(Max)
Brightness	400lm(Max)	500lm(Max)
Lighting Distance	160m	/
Battery Duration	5H(Max), 50H(Lowest)	4-60H
Battery Capacity	3.7V 2000mAh	
Charge Time	2H	
IP Grade	IP66	
Weight	190g	
Size	200x41.5x39mm	

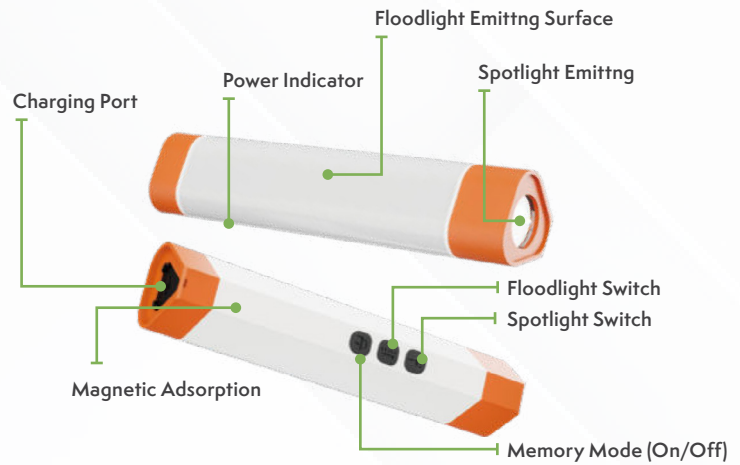

## DIMENSION

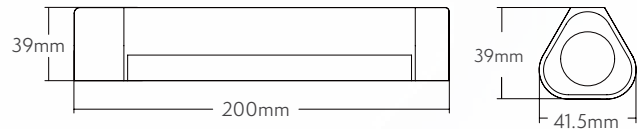

Package	Description
Size of Box	70x55x205mm
Gross Weight	250g
Size of Carton	590x310x250mm
Gross Weight	12.0kg
Box Quantity/ Carton	40Pcs



Spotlight



Floodlight



Red/Blue Warning Light



Extra Long Duration



Waterproof



Emergency Charging



Magnetic Attach



Anti-impact

## FLOODLIGHT MODE



High Output Mode

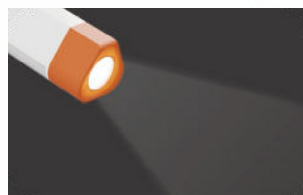

Low Output Mode

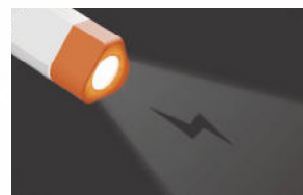

Flash Mode

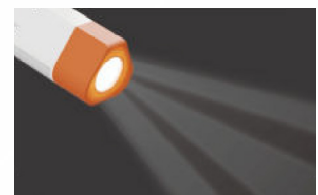

SOS Mode  
(Regular Flicker)

## FLOODLIGHT MODE



Floodlight Mode



Stepless Dimming

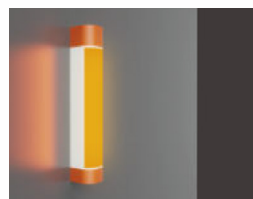

Yellow Light

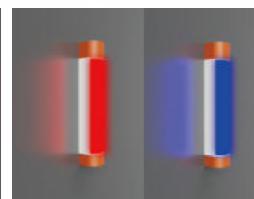

Red/Blue Light

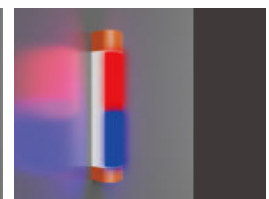

Red + Blue  
Flash Light

# Portable Lights

## MAX-PT-200 Portable Pan-Tilt Light

A New Remote Lighting Experience: Illuminate Your Space at Will. Bringing a personal lighting technician to your work stage. All directional, Precise project, Dimmable, and Remote-Controlled Lighting: "Shape the Perfect Illumination for Your Workspace"

### PRODUCT FEATURES

- » High brightness lighting
- » Type-C charging
- » Pattern memory
- » Minimum standby power consumption
- » 6 light modes
- » 360° rotatable

Specification	Description
Weight	4.4kg (Fitting only)
Power Supply	Battery
Lumens	0 - 12,000Lm
Run Times	>4 hours (Standard mode, D24-100)
IP Grade	IP66
Battery System	D24 Series
Working Temperature	-10°C-50°C
Working Humidity	1-98%



### PACKAGE

Model	Size of Carton	Gross Weight of Carton	Quantity
MAX-PT-200	330x275x460mm	5.5 kg ± 5%	1



### Directional Control Joystick

#### 180-Degree Vertical Rotation

Rotates up to 180 degrees up and down, precisely pointing to any target position.



#### 360-Degree Horizontal Rotation

Rotate freely in 360 degrees horizontal direction, instantly rotate/stop with remote commands.

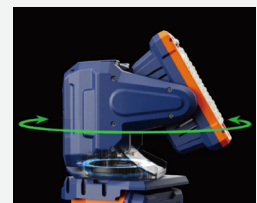

# MAX-PT-200 Portable Pan-Tilt Light

## One more mount mode: magnetic attachment

The strong magnetic base can be attached to any iron surface, such as a car hood. The magnetic base allows users to flexibly choose different adhesion angles according to their actual needs. Equipped with a safety cord, magnetic suction is more secure.



 Standard mode up to **4+** Hours (D24-100)

Battery-powered Up To 12,000 LM.

### Battery (3 Modes):

- » Turbo (12,000LM)
- » Standard (6,500LM)
- » Eco (1,200LM)

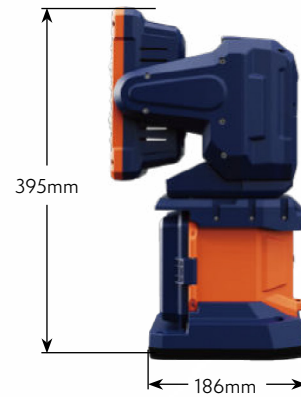

## Three Lighting Modes:



Distance Mode



Distance Mode



Distance Mode

# MAX-PT-200H Portable Pan-Tilt Tripod Light

## APPLICATIONS

- » Construction
- » Mining
- » Emergency
- » Highway
- » Military
- » Heavy Lifting
- » Railway
- » Electric Power

Specification	Description
Weight	4.4kg (Fitting only)
Power Supply	Battery
Lumens	0 - 12,000Lm
Run Times	>4 hours (Standard mode, D24-100)
IP Grade	IP66
Battery System	D24 Series
Working Temperature	-10°C-50°C
Working Humidity	1-98%



### 30 Meters Remote Range

Remote control for adjusting the light head.completed in 10 seconds.



### Phone Stand

Continue working while charging, the hook here can serve as a phone stand.



### Car Charger

Use the CC-3 car charger to charge the PT-200H in the car.



### Directional Control Joystick

#### 180-Degree Vertical Rotation

Rotates up to 180 degrees up and down, precisely pointing to any target position.



#### 360-Degree Horizontal Rotation

Rotate freely in 360 degrees horizontal direction, instantly rotate/stop with remote commands.

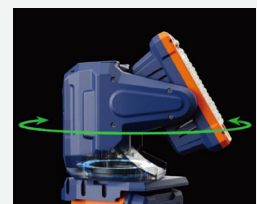

# MAX-PT-200H Portable Pan-Tilt Tripod Light

## Lower center of gravity, greater stability.

Ultra-low center of gravity combined with extended legs effortlessly handles strong winds and slopes.



## Ultra-long working hours

Battery compartment fits two replaceable battery packs.

Battery-powered Up To 12,000 LM.

### Battery (3 Modes):

- » Turbo (12,000LM)
- » Standard (6,500LM)
- » Eco (1,200LM)

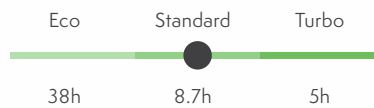

 Standard mode up to **8+** Hours (D24-100 x 2)

## High light efficiency, illuminating a wider space

Equipped with high-brightness LED light source and high-quality optical lens system

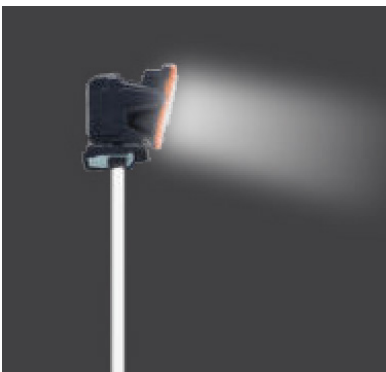

Distance Mode



Midrange Mode

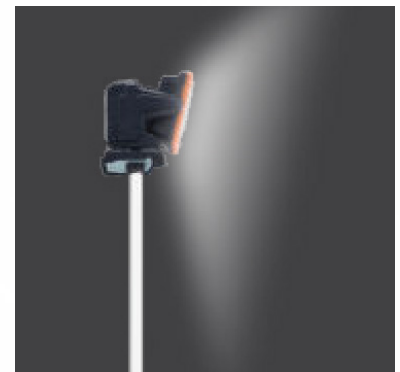

Close-range Mode

# MAX-PT-200H Portable Pan-Tilt Tripod Light

## High light efficiency, illuminating a wider space

Equipped with high-brightness LED light source and high-quality optical lens system

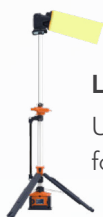

### Long distance

Ultra-high brightness focused lighting.

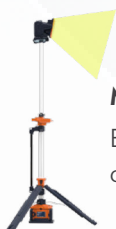

### Medium distance

Balancing illumination distance and brightness.

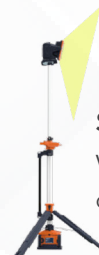

### Short distance

Wide-area lighting coverage

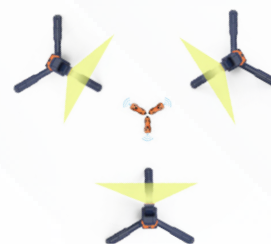
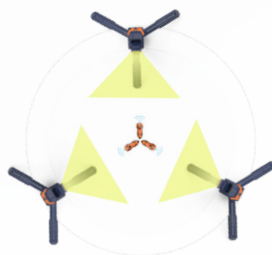

## PACKAGE

Model	Size of Carton	Gross Weight of Carton	Quantity
MAX-TL-200H	1550x270x360mm	13kg	1

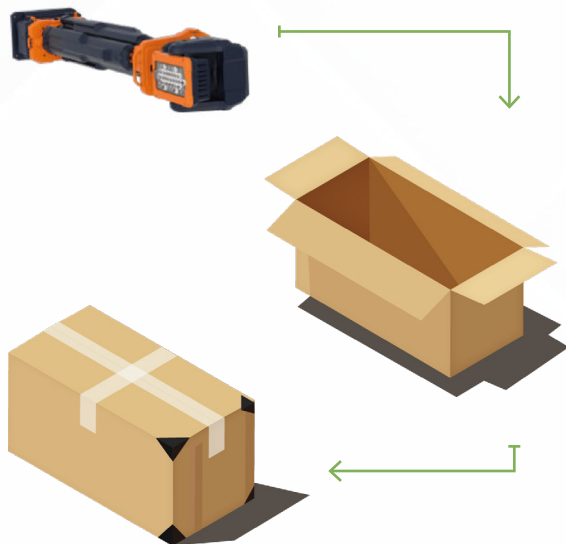

## DIMENSIONS

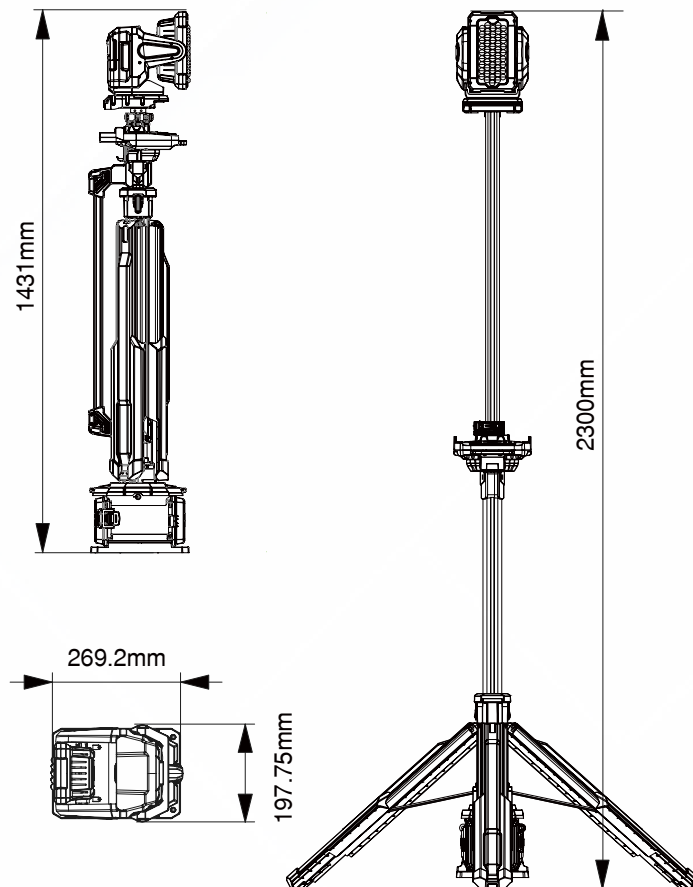

# MAX-TL-500 Portable Light Tower

**Handheld controller**  
With spring wire, no need to bend over to operate

Button	Function
	Dimming
	Brightness Level
	Power
	Mode
	Up
	Down



MAX-TL-500

**A handle that provides the best grip** doubles as lift point. Special slots are compatible with small warning lights.

**Multifunctional storage space design**

- » Equipped with multiple interfaces to charge devices
- » Waterproof toolbox

**Unique coaxial 3-wheel design**

- » Climbs heights without a forklift if necessary
- » Stays stable on muddy ground with maximum contact surface

**Didn't change the battery in time?**  
Don't worry, disengage the clutch, then manually retract the pole

Wading depth up to 10cm refers to the water line mark on the light tower body

## BATTERY

- » Ultra-Long Working Hours
- » Portable lithium battery with large capacity in a small size
- » With 3 of fully charged battery power alone, it can provide 10-100 hours lighting
- » It also supports using an AC driver for direct power connection.

**10 - 100** Hours  
Turbo Mode Eco Mode



AC driver for direct power



D24-500 Battery (3kg)



D24-500 Battery (3kg)

# MAX-TL-500 Portable Light Tower

## PRODUCT FEATURES

- » High-efficiency LED light source
- » Free switching of multiple angles

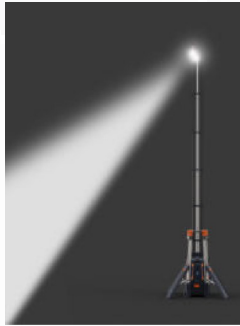

Distance Mode

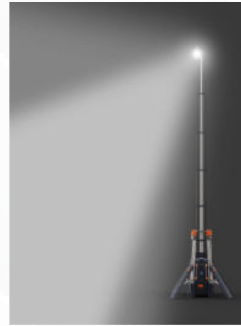

Midrange Mode



Close-range Mode

## BATTERY-POWERED

Model	Brightness
MAX-TL-500 4.2m	Up to 33,000LM
MAX-TL-500 5.3m	Up to 35,000LM

## AC POWERED

Model	Brightness
MAX-TL-500 4.2m	Up to 62,000LM
MAX-TL-500 5.3m	Up to 65,000LM

## 4 LEVELS OF BRIGHTNESS (Battery Powered)

	Eco	Balanced	Standard	Turbo
5.3m	3,000LM	10,000LM	18,000LM	35,000LM
4.2m	2,800LM	9,500LM	17,000LM	33,000LM

## STEPLESS DIMMABLE (AC Powered)

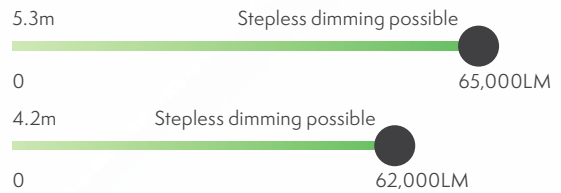

The brightness and battery level can be viewed on the controller when using batteries.

When AC powered, knob on driver controls 0-100% dimming.



# MAX-TL-500 Portable Light Tower

## OPTIONAL ACCESSORIES

A variety of accessories are available to expand the power supply options.



9 Bay Charger Case (3x D24-500 Available) + Solar Panel



Charger (MC-2H)



Battery (D24-500)



Driver - AC100-277V Input (X5-320)



## ONE-PERSON OPERATION

Designed for ease and speed, this unit allows a single operator to transport, deploy, and adjust the lighting setup without assistance — making it ideal for demanding environments where time and efficiency matter.

- » Construction
- » Mining
- » Emergency
- » Sport
- » Firefighting
- » Event

The total light tower weight (excluding battery pack) is 50 kg for the 4.2 m model and 52 kg for the 5.3 m model.

For quick deployment in emergencies this equipment fits easily into standard SUVs for single-person loading.



# MAX-TL-500 Portable Light Tower

## MAX-TL-500 4.2M

Specification	Description
Height	4.2m
Weight	50kg (Fitting only)
Power Supply	Battery / AC 100-277V
Lumens	Battery 0-33,000LM / AC 0-62, 000LM
Run Times	>20h (Standard mode, D24-500 x 3)
IP Grade	IP65
Output (USB)	Type-A (5V 2A) and Type-C (5V 2A)
Battery System	D24 Series

## MAX-TL-500 5.3M

Specification	Description
Height	5.3m
Weight	52kg (Fitting only)
Power Supply	Battery / AC 100-277V
Lumens	Battery 0-35,000LM / AC 0-65, 000LM
Run Times	>20h (Standard mode, D24-500 x 3)
IP Grade	IP65
Output (USB)	Type-A (5V 2A) and Type-C (5V 2A)
Battery System	D24 Series

## DIMENSIONS

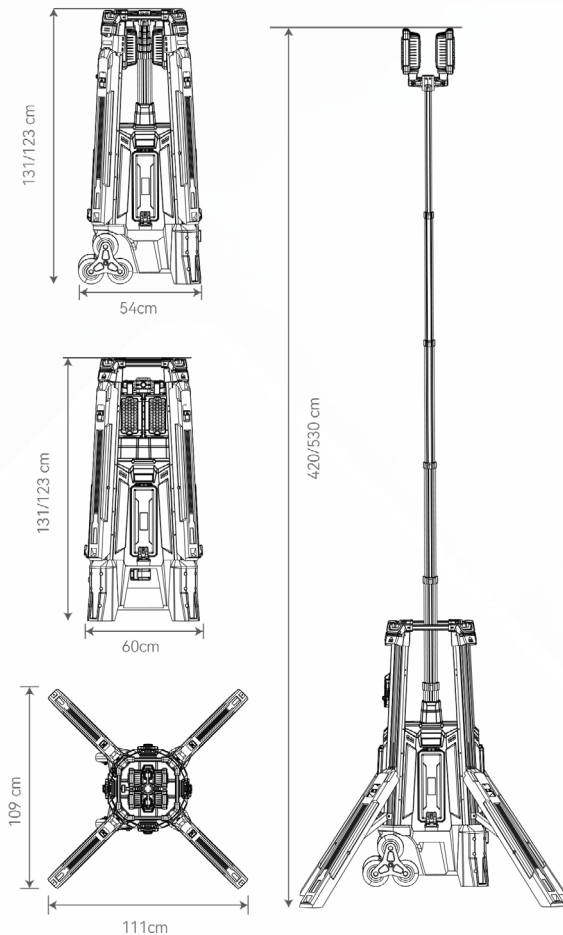

## PACKAGE

Model	Size of Carton	Gross Weight of Carton	Quantity
MAX-TL-500	640x640x1460mm	64kg	1

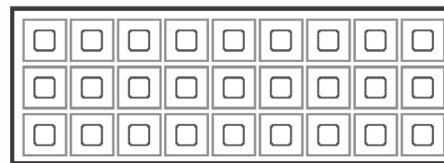
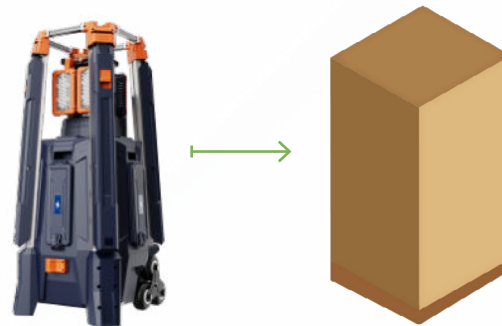

20GP Container, 27 Unit

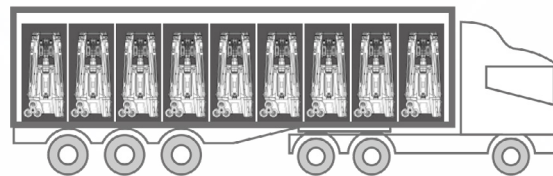

240GP Container, 57 Unit



More safety barrier solutions and signage available.  
 Contact us on [1300 222 862](tel:1300222862) or [sales@accumax.com.au](mailto:sales@accumax.com.au) to learn more.  
[accumax.com.au](http://accumax.com.au)